

NOTES:

1.MATERIALS:

1-1.HOUSING: SEE TABLE ,GLASS FIBER FILLED UL94V-0, COLOR: SEE TABLE.

1-2.CONTACT: SEE TABLE

2.PLATING:

2-1.CONTACT AREA: GOLD, THICKNESS : SEE TABLE .

2-2.SOLDER TAIL: 100 MICRINCH MIN. TIN PLATING.

2-3.UNDER PLATING: NICKEL PLATING OVERALL.

3.WEEK CODE: XX(YEAR) XX(WEEK) X(LOCATION).

4.PRODUCT SPECIFICATION REFER TO PS-87715-200.

5.PACKAGING SPECIFICATION REFER TO PK-87715-207.

6.TEST SUMMARY:REFER TO TS-87715-207.

7.LEAD FREE AND ROHS COMPLIANCE PRODUCT.

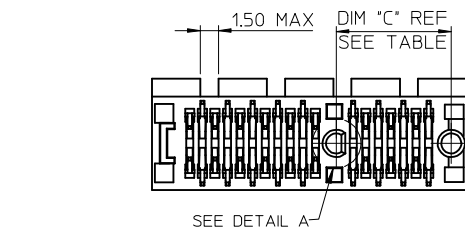
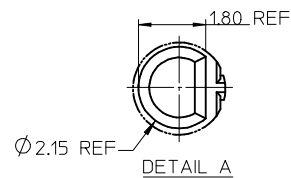
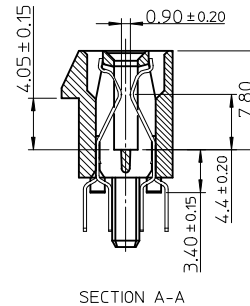
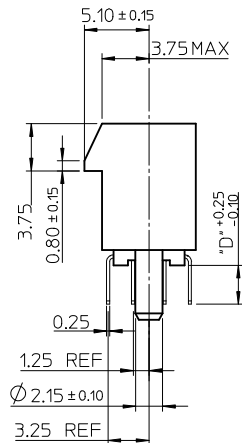
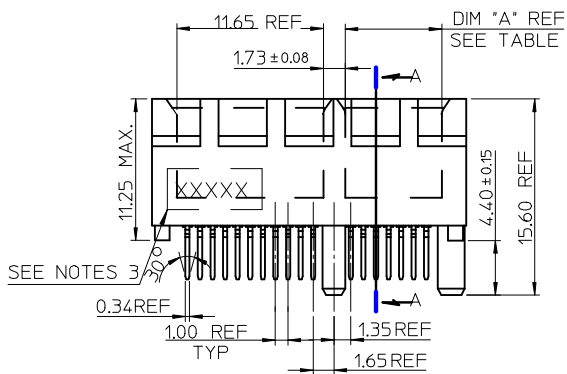

CONNECTOR LINK WIDTH	# POS REF	N	DIM 'A'	DIM 'B'	DIM 'C'
X1	36	6	7.65	25.00	9.15
X4	64	20	21.65	39.00	23.15
X8	98	37	38.65	56.00	40.15
X16	164	70	71.65	89.00	73.15

PCB THK (REF)	DIM 'D'
1.60	2.30
1.58	2.54
2.36	3.00

<p>CORRECT P/N</p> <p>EC NO: SH2009-0199 2008/10/13 DRWN:GWANG08 2008/10/17 CHKD:DMZHANG02 2008/10/17 APPR:HMWANG 2008/11/03</p>	<p>QUALITY SYMBOLS</p> <p>▽=0 ◻=0</p>	<p>GENERAL TOLERANCES (UNLESS SPECIFIED)</p> <table border="1"> <thead> <tr> <th></th> <th>mm</th> <th>INCH</th> </tr> </thead> <tbody> <tr> <td>4 PLACES</td> <td>± ---</td> <td>± ---</td> </tr> <tr> <td>3 PLACES</td> <td>± ---</td> <td>± ---</td> </tr> <tr> <td>2 PLACES</td> <td>± 0.25</td> <td>± ---</td> </tr> <tr> <td>1 PLACE</td> <td>± 0.25</td> <td>± ---</td> </tr> </tbody> </table> <p>ANGULAR ± 3 °</p>		mm	INCH	4 PLACES	± ---	± ---	3 PLACES	± ---	± ---	2 PLACES	± 0.25	± ---	1 PLACE	± 0.25	± ---	<p>DIMENSION STYLE</p> <p>MM ONLY</p>	<p>SCALE</p> <p>DESIGN UNITS</p> <p>METRIC</p>	<p>THIRD ANGLE PROJECTION</p>
		mm	INCH																	
	4 PLACES	± ---	± ---																	
	3 PLACES	± ---	± ---																	
2 PLACES	± 0.25	± ---																		
1 PLACE	± 0.25	± ---																		
		<p>DRAWN BY</p> <p>TOM</p>	<p>DATE</p> <p>2004/07/20</p>	<p>TITLE</p> <p>PCI EXPRESS EDGE CARD CONNECTOR (LEAD FREE VERSION)</p>																
		<p>CHECKED BY</p> <p>ALLEN LIN</p>	<p>DATE</p> <p>2004/07/20</p>	<p>MOLEX INCORPORATED</p>																
		<p>APPROVED BY</p> <p>WILSON</p>	<p>DATE</p> <p>2004/07/20</p>	<p>MATERIAL NO.</p> <p>SEE TABLE</p>	<p>DOCUMENT NO.</p> <p>SD-87715-207</p>															

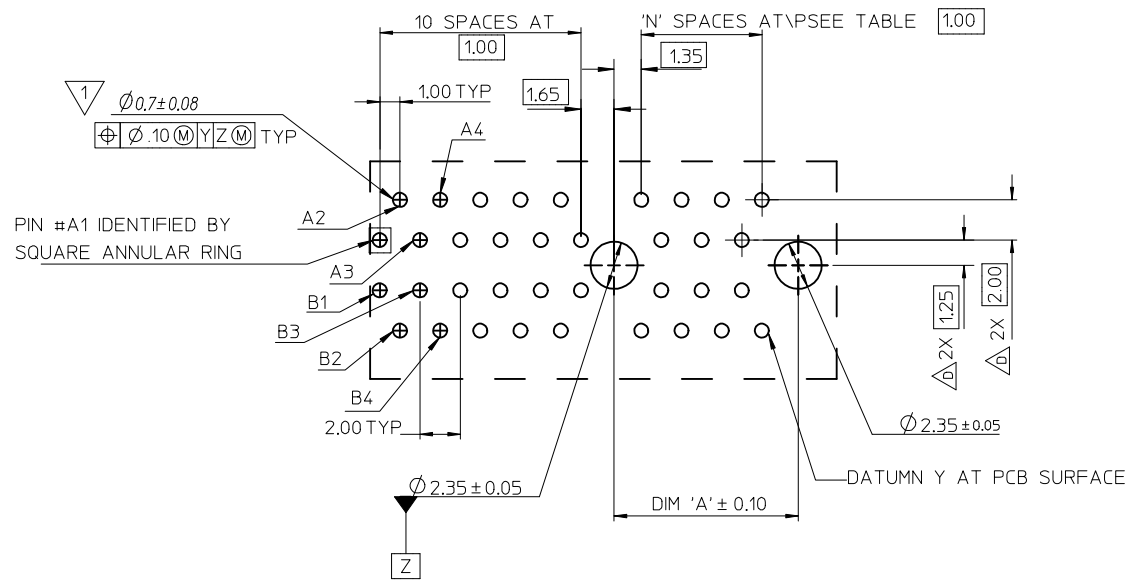

1 THE HORIZONTAL AXIS FOR THE HOLE PATTERN IS ESTABLISHED BY A LINE THROUGH THE CENTER OF THE TWO $\varnothing 2.35$ HOLES. THE VERTICAL AXIS IS 90° TO THE HORIZONTAL AXIS, THROUGH THE CENTER OF DATUM Z

CONNECTOR LINK WIDTH	# POS REF	N	DIM 'A'
X1	36	6	9.15
X4	64	20	23.15
X8	98	37	40.15
X16	164	70	73.15

SEE SHEET 1 EC NO: SH2009-0199 DRAWN: GWANG08 CH'KD: DMZHANG02 APPR: HWANG	2008/10/13 2008/10/17 2008/11/03	DESCRIPTION REV	QUALITY SYMBOLS	GENERAL TOLERANCES (UNLESS SPECIFIED)	DIMENSION STYLE	SCALE	DESIGN UNITS	THIRD ANGLE PROJECTION	
			$\nabla = 0$ $\nabla = 0$	mm INCH 4 PLACES \pm --- \pm --- 3 PLACES \pm --- \pm --- 2 PLACES ± 0.25 \pm --- 1 PLACE ± 0.25 \pm --- ANGULAR $\pm 3^\circ$	MM ONLY		METRIC		
				DRAFT WHERE APPLICABLE MUST REMAIN WITHIN DIMENSIONS	DRAWN BY: TOM CHECKED BY: ALLEN LIN APPROVED BY: WILSON	DATE: 2004/07/20 DATE: 2004/07/20 DATE: 2004/07/20	TITLE: PCI EXPRESS EDGE CARD CONNECTOR (LEAD FREE VERSION)		
					MATERIAL NO.: SEE TABLE SIZE: A3	DOCUMENT NO.: SD-87715-207 SHEET NO.: 2 OF 11	MOLEX INCORPORATED		

THIS DRAWING CONTAINS INFORMATION THAT IS PROPRIETARY TO MOLEX INCORPORATED AND SHOULD NOT BE USED WITHOUT WRITTEN PERMISSION

10 9 8 7 6 5 4 3 2 1

F

E

D

C

B

A

F

E

D

C

B

A

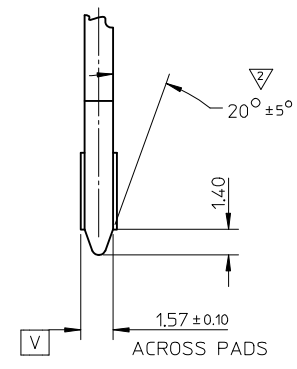
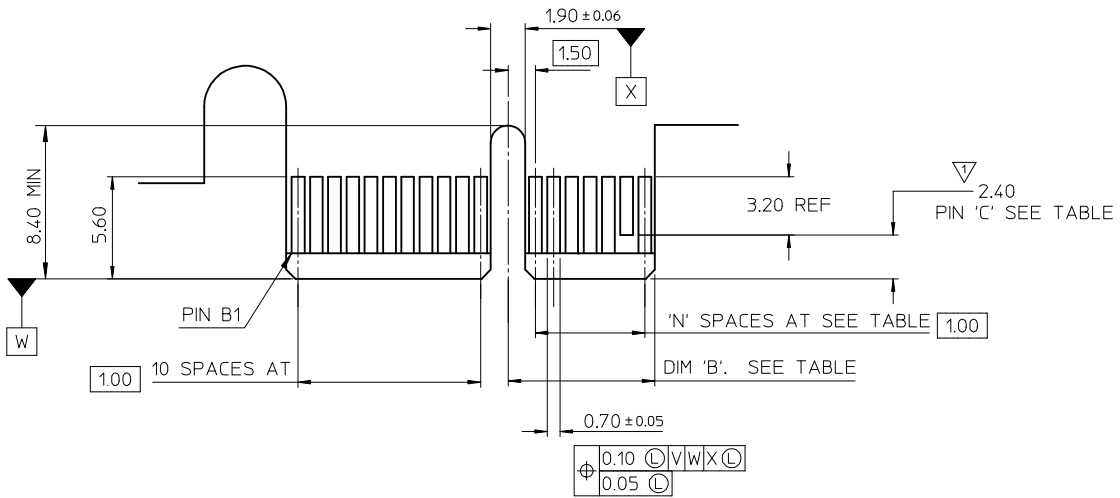

← I/O PANEL DIRECTION

PRIMARY (COMPONENT) SIDE

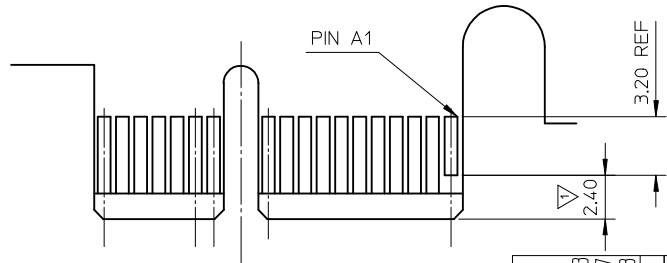

I/O PANEL DIRECTION →
SECONDARY (SOLDER) SIDE

- 1 NO TIE BAR PERMITTED FROM CARD EDGE TO LEADING EDGE OF PAD FOR PINS A1 AND "C".
- 2 CHAMFER EDGES MUST BE FREE OF CUTTING BURRS.
- 3. TOLERANCE: .XX±.13

CONNECTOR LINK WIDTH	# POS REF	N	DIM 'B'	'C'
X1	36	6	8.15	B17
X4	64	20	22.15	B17, B31
X8	98	37	39.15	B17, B31 B48
X16	164	70	72.15	B17, B31 B48, B81

SEE SHEET 1 EC NO: SH2009-0199 DRAWING: GWANG08 CHK'D: DMZHANG02 APPR: HWANG 2008/10/13 2008/10/17 2008/11/03	QUALITY SYMBOLS	GENERAL TOLERANCES (UNLESS SPECIFIED)	DIMENSION STYLE	SCALE	DESIGN UNITS	THIRD ANGLE PROJECTION	
	▽=0 =0	mm INCH 4 PLACES ± --- ± --- 3 PLACES ± --- ± --- 2 PLACES ± 0.25 ± --- 1 PLACE ± 0.25 ± --- ANGULAR ± 3 °	MM ONLY	DRAWN BY: TOM DATE: 2004/07/20 CHECKED BY: ALLEN LIN DATE: 2004/07/20 APPROVED BY: WILSON DATE: 2004/07/20	METRIC	TITLE	PCI EXPRESS EDGE CARD CONNECTOR (LEAD FREE VERSION)
	DRAFT WHERE APPLICABLE MUST REMAIN WITHIN DIMENSIONS	SEE TABLE	MATERIAL NO. SD-87715-207	MOLEX INCORPORATED	SHEET NO. 3 OF 11		
	SIZE A3	THIS DRAWING CONTAINS INFORMATION THAT IS PROPRIETARY TO MOLEX INCORPORATED AND SHOULD NOT BE USED WITHOUT WRITTEN PERMISSION					

9 8 7 6 5 4 3 2 1

10 9 8 7 6 5 4 3 2 1

MOLEX P/N	CIRCUIT SIZE	HOUSING MATERIAL	HOUSING COLOR	TERMINAL MATERIAL	CONTACT PLATING	SOLDER TAIL 'D' LENGTH
87715-6000	36	NYLON66	BLACK	PHOSPHOR BRONZE	GOLD FLASH	2.54
87715-6001					10 MICROINCH	
87715-6002					15 MICROINCH	
87715-6003					GOLD FLASH	
87715-6004					10 MICROINCH	
87715-6005					15 MICROINCH	
87715-6006					30 MICROINCH	
87715-6007					GOLD FLASH	
87715-6008					15 MICROINCH	
87715-6009					30 MICROINCH	
87715-6010	36	NYLON66	WHITE	PHOSPHOR BRONZE	GOLD FLASH	2.54
87715-6011					10 MICROINCH	
87715-6012					15 MICROINCH	
87715-6013					GOLD FLASH	
87715-6014					10 MICROINCH	
87715-6015					15 MICROINCH	
87715-6016					30 MICROINCH	
87715-6017					GOLD FLASH	
87715-6018					15 MICROINCH	
87715-6020					36	
87715-6021	10 MICROINCH					
87715-6022	15 MICROINCH					
87715-6023	GOLD FLASH					
87715-6024	10 MICROINCH					
87715-6025	15 MICROINCH					
87715-6026	30 MICROINCH					
87715-6027	GOLD FLASH					
87715-6028	15 MICROINCH					
87715-6030	36	NYLON66	GREEN (348C)	PHOSPHOR BRONZE		GOLD FLASH
87715-6031					10 MICROINCH	
87715-6032					15 MICROINCH	
87715-6033					GOLD FLASH	
87715-6034					10 MICROINCH	
87715-6035					15 MICROINCH	
87715-6036					30 MICROINCH	
87715-6037					GOLD FLASH	
87715-6038					15 MICROINCH	
87715-6040					36	NYLON66
87715-6041	10 MICROINCH					
87715-6042	15 MICROINCH					
87715-6043	GOLD FLASH					
87715-6044	10 MICROINCH					
87715-6045	15 MICROINCH					
87715-6046	30 MICROINCH					
87715-6047	GOLD FLASH					
87715-6048	15 MICROINCH					

MOLEX P/N	CIRCUIT SIZE	HOUSING MATERIAL	HOUSING COLOR	TERMINAL MATERIAL	CONTACT PLATING	SOLDER TAIL 'D' LENGTH
87715-6100	64	NYLON66	BLACK	PHOSPHOR BRONZE	GOLD FLASH	3.00
87715-6101					10 MICROINCH	
87715-6102					15 MICROINCH	
87715-6103					GOLD FLASH	
87715-6104					10 MICROINCH	
87715-6105					15 MICROINCH	
87715-6106					30 MICROINCH	
87715-6107					GOLD FLASH	
87715-6108					15 MICROINCH	
87715-6109					30 MICROINCH	
87715-6110	64	NYLON66	WHITE	PHOSPHOR BRONZE	GOLD FLASH	2.54
87715-6111					10 MICROINCH	
87715-6112					15 MICROINCH	
87715-6113					GOLD FLASH	
87715-6114					10 MICROINCH	
87715-6115					15 MICROINCH	
87715-6116					30 MICROINCH	
87715-6117					GOLD FLASH	
87715-6118					15 MICROINCH	
87715-6120					64	
87715-6121	10 MICROINCH					
87715-6122	15 MICROINCH					
87715-6123	GOLD FLASH					
87715-6124	10 MICROINCH					
87715-6125	15 MICROINCH					
87715-6126	30 MICROINCH					
87715-6127	GOLD FLASH					
87715-6128	15 MICROINCH					
87715-6130	64	NYLON66	GREEN (348C)	PHOSPHOR BRONZE		GOLD FLASH
87715-6131					10 MICROINCH	
87715-6132					15 MICROINCH	
87715-6133					GOLD FLASH	
87715-6134					10 MICROINCH	
87715-6135					15 MICROINCH	
87715-6136					30 MICROINCH	
87715-6137					GOLD FLASH	
87715-6138					15 MICROINCH	
87715-6140					64	NYLON66
87715-6141	10 MICROINCH					
87715-6142	15 MICROINCH					
87715-6143	GOLD FLASH					
87715-6144	10 MICROINCH					
87715-6145	15 MICROINCH					
87715-6146	30 MICROINCH					
87715-6147	GOLD FLASH					
87715-6148	15 MICROINCH					

SEE SHEET 1 EC NO: SH2009-0199 DRWN:GWANG08 2008/08/19/17 CHKD:DMZHANG02 APPR:HWANG 2008/11/03 REV	QUALITY SYMBOLS ▽=0 ▽=0	GENERAL TOLERANCES (UNLESS SPECIFIED) <table border="1"> <tr><th colspan="2">mm</th><th>INCH</th></tr> <tr><td>4 PLACES</td><td>± .005</td><td>± .0004</td></tr> <tr><td>3 PLACES</td><td>± .005</td><td>± .0004</td></tr> <tr><td>2 PLACES</td><td>± 0.25</td><td>± .010</td></tr> <tr><td>1 PLACE</td><td>± 0.25</td><td>± .010</td></tr> </table> ANGULAR ± 3°	mm		INCH	4 PLACES	± .005	± .0004	3 PLACES	± .005	± .0004	2 PLACES	± 0.25	± .010	1 PLACE	± 0.25	± .010	DIMENSION STYLE MM ONLY DRAWN BY: TOM DATE: 2004/07/20 CHECKED BY: ALLEN LIN DATE: 2004/07/20 APPROVED BY: WILSON DATE: 2004/07/20	SCALE DESIGN UNITS METRIC	THIRD ANGLE PROJECTION
	mm		INCH																	
	4 PLACES	± .005	± .0004																	
	3 PLACES	± .005	± .0004																	
2 PLACES	± 0.25	± .010																		
1 PLACE	± 0.25	± .010																		
DRAFT WHERE APPLICABLE MUST REMAIN WITHIN DIMENSIONS			MATERIAL NO. SEE TABLE	DOCUMENT NO. SD-87715-207	SHEET NO. 4 OF 11															
PCI EXPRESS EDGE CARD CONNECTOR (LEAD FREE VERSION) MOLEX INCORPORATED																				
THIS DRAWING CONTAINS INFORMATION THAT IS PROPRIETARY TO MOLEX INCORPORATED AND SHOULD NOT BE USED WITHOUT WRITTEN PERMISSION																				

9 8 7 6 5 4 3 2 1



MOLEX P/N	CIRCUIT SIZE	HOUSING MATERIAL	HOUSING COLOR	TERMINAL MATERIAL	CONTACT PLATING	SOLDER TAIL 'D' LENGTH	
87715-6200	98	NYLON66	BLACK	PHOSPHOR BRONZE	GOLD FLASH	2.54	
87715-6201					10 MICROINCH		
87715-6202					15 MICROINCH		
87715-6203					GOLD FLASH		
87715-6204					10 MICROINCH		3.00
87715-6205					15 MICROINCH		
87715-6206					30 MICROINCH		2.54
87715-6207					GOLD FLASH		2.30
87715-6208					15 MICROINCH		
87715-6209					30 MICROINCH		3.00
87715-6210	98	NYLON66	WHITE	PHOSPHOR BRONZE	GOLD FLASH	2.54	
87715-6211					10 MICROINCH		
87715-6212					15 MICROINCH		
87715-6213					GOLD FLASH		
87715-6214					10 MICROINCH		3.00
87715-6215					15 MICROINCH		
87715-6216					30 MICROINCH		2.54
87715-6217					GOLD FLASH		2.30
87715-6218					15 MICROINCH		
87715-6220					98		NYLON66
87715-6221	10 MICROINCH						
87715-6222	15 MICROINCH						
87715-6223	GOLD FLASH						
87715-6224	10 MICROINCH	3.00					
87715-6225	15 MICROINCH						
87715-6226	30 MICROINCH	2.54					
87715-6227	GOLD FLASH	2.30					
87715-6228	15 MICROINCH						
87715-6230	98	NYLON66	GREEN (348C)	PHOSPHOR BRONZE		GOLD FLASH	
87715-6231					10 MICROINCH		
87715-6232					15 MICROINCH		
87715-6233					GOLD FLASH		
87715-6234					10 MICROINCH	3.00	
87715-6235					15 MICROINCH		
87715-6236					30 MICROINCH	2.54	
87715-6237					GOLD FLASH	2.30	
87715-6238					15 MICROINCH		
87715-6240					98	NYLON66	PURPLE (2736U)
87715-6241	10 MICROINCH						
87715-6242	15 MICROINCH						
87715-6243	GOLD FLASH						
87715-6244	10 MICROINCH	3.00					
87715-6245	15 MICROINCH						
87715-6246	30 MICROINCH	2.54					
87715-6247	GOLD FLASH	2.30					
87715-6248	15 MICROINCH						

MOLEX P/N	CIRCUIT SIZE	HOUSING MATERIAL	HOUSING COLOR	TERMINAL MATERIAL	CONTACT PLATING	SOLDER TAIL 'D' LENGTH	
87715-6300	164	NYLON66	BLACK	PHOSPHOR BRONZE	GOLD FLASH	2.54	
87715-6301					10 MICROINCH		
87715-6302					15 MICROINCH		
87715-6303					GOLD FLASH		
87715-6304					10 MICROINCH		3.00
87715-6305					15 MICROINCH		
87715-6306					30 MICROINCH		2.54
87715-6307					GOLD FLASH		2.30
87715-6308					15 MICROINCH		
87715-6309					30 MICROINCH		3.00
87715-6310	164	NYLON66	WHITE	PHOSPHOR BRONZE	GOLD FLASH	2.54	
87715-6311					10 MICROINCH		
87715-6312					15 MICROINCH		
87715-6313					GOLD FLASH		
87715-6314					10 MICROINCH		3.00
87715-6315					15 MICROINCH		
87715-6316					30 MICROINCH		2.54
87715-6317					GOLD FLASH		2.30
87715-6318					15 MICROINCH		
87715-6320					164		NYLON66
87715-6321	10 MICROINCH						
87715-6322	15 MICROINCH						
87715-6323	GOLD FLASH						
87715-6324	10 MICROINCH	3.00					
87715-6325	15 MICROINCH						
87715-6326	30 MICROINCH	2.54					
87715-6327	GOLD FLASH	2.30					
87715-6328	15 MICROINCH						
87715-6330	164	NYLON66	GREEN (348C)	PHOSPHOR BRONZE		GOLD FLASH	
87715-6331					10 MICROINCH		
87715-6332					15 MICROINCH		
87715-6333					GOLD FLASH		
87715-6334					10 MICROINCH	3.00	
87715-6335					15 MICROINCH		
87715-6336					30 MICROINCH	2.54	
87715-6337					GOLD FLASH	2.30	
87715-6338					15 MICROINCH		
87715-6340					164	NYLON66	PURPLE (2736U)
87715-6341	10 MICROINCH						
87715-6342	15 MICROINCH						
87715-6343	GOLD FLASH						
87715-6344	10 MICROINCH	3.00					
87715-6345	15 MICROINCH						
87715-6346	30 MICROINCH	2.54					
87715-6347	GOLD FLASH	2.30					
87715-6348	15 MICROINCH						

2008/10/17

2008/10/17

SEE SHEET 1
 EC NO: SH2009-0199
 DRW:GWANG08 2008/10/13
 CHK:DMZHANG02 2008/10/17
 APPR:HWANG 2008/11/03



QUALITY SYMBOLS
 = 0
 = 0.25

GENERAL TOLERANCES (UNLESS SPECIFIED)

mm		INCH	
4 PLACES	± ---	± ---	
3 PLACES	± ---	± ---	
2 PLACES	± 0.25	± ---	
1 PLACE	± 0.25	± ---	

 ANGULAR ± 3 °
 DRAFT WHERE APPLICABLE
 MUST REMAIN
 WITHIN DIMENSIONS

DIMENSION STYLE
MM ONLY
 DRAWN BY: TOM
 DATE: 2004/07/20
 CHECKED BY: ALLEN LIN
 DATE: 2004/07/20
 APPROVED BY: WILSON
 DATE: 2004/07/20
 MATERIAL NO. SEE TABLE

SCALE: METRIC
 DESIGN UNITS: MM
 THIRD ANGLE PROJECTION
**PCI EXPRESS
 EDGE CARD CONNECTOR
 (LEAD FREE VERSION)**
 **MOLEX INCORPORATED**
 DOCUMENT NO. SD-87715-207
 SHEET NO. 5 OF 11
 THIS DRAWING CONTAINS INFORMATION THAT IS PROPRIETARY TO MOLEX INCORPORATED AND SHOULD NOT BE USED WITHOUT WRITTEN PERMISSION

MOLEX P/N	CIRCUIT SIZE	HOUSING MATERIAL	HOUSING COLOR	TERMINAL MATERIAL	CONTACT PLATING	SOLDER TAIL 'D' LENGTH
87715-6400	36	NYLON66	BLACK	BRASS	GOLD FLASH	2.54
87715-6401					10 MICROINCH	
87715-6402					15 MICROINCH	
87715-6403					GOLD FLASH	
87715-6404					10 MICROINCH	
87715-6405					15 MICROINCH	
87715-6406	30 MICROINCH	2.54				
87715-6407	GOLD FLASH	2.30				
87715-6408	15 MICROINCH					
87715-6410	36	NYLON66	WHITE	BRASS	GOLD FLASH	2.54
87715-6411					10 MICROINCH	
87715-6412					15 MICROINCH	
87715-6413					GOLD FLASH	
87715-6414					10 MICROINCH	
87715-6415					15 MICROINCH	
87715-6416	30 MICROINCH	2.54				
87715-6417	GOLD FLASH	2.30				
87715-6418	15 MICROINCH					
87715-6420	36	NYLON66	BLUE (287U)	BRASS	GOLD FLASH	2.54
87715-6421					10 MICROINCH	
87715-6422					15 MICROINCH	
87715-6423					GOLD FLASH	
87715-6424					10 MICROINCH	
87715-6425					15 MICROINCH	
87715-6426	30 MICROINCH	2.54				
87715-6427	GOLD FLASH	2.30				
87715-6428	15 MICROINCH					
87715-6430	36	NYLON66	GREEN (348C)	BRASS	GOLD FLASH	2.54
87715-6431					10 MICROINCH	
87715-6432					15 MICROINCH	
87715-6433					GOLD FLASH	
87715-6434					10 MICROINCH	
87715-6435					15 MICROINCH	
87715-6436	30 MICROINCH	2.54				
87715-6437	GOLD FLASH	2.30				
87715-6438	15 MICROINCH					
87715-6440	36	NYLON66	PURPLE (2736U)	BRASS	GOLD FLASH	2.54
87715-6441					10 MICROINCH	
87715-6442					15 MICROINCH	
87715-6443					GOLD FLASH	
87715-6444					10 MICROINCH	
87715-6445					15 MICROINCH	
87715-6446	30 MICROINCH	2.54				
87715-6447	GOLD FLASH	2.30				
87715-6448	15 MICROINCH					

MOLEX P/N	CIRCUIT SIZE	HOUSING MATERIAL	HOUSING COLOR	TERMINAL MATERIAL	CONTACT PLATING	SOLDER TAIL 'D' LENGTH
87715-6500	64	NYLON66	BLACK	BRASS	GOLD FLASH	2.54
87715-6501					10 MICROINCH	
87715-6502					15 MICROINCH	
87715-6503					GOLD FLASH	
87715-6504					10 MICROINCH	
87715-6505					15 MICROINCH	
87715-6506	30 MICROINCH	2.54				
87715-6507	GOLD FLASH	2.30				
87715-6508	15 MICROINCH					
87715-6510	64	NYLON66	WHITE	BRASS	GOLD FLASH	2.54
87715-6511					10 MICROINCH	
87715-6512					15 MICROINCH	
87715-6513					GOLD FLASH	
87715-6514					10 MICROINCH	
87715-6515					15 MICROINCH	
87715-6516	30 MICROINCH	2.54				
87715-6517	GOLD FLASH	2.30				
87715-6518	15 MICROINCH					
87715-6520	64	NYLON66	BLUE (287U)	BRASS	GOLD FLASH	2.54
87715-6521					10 MICROINCH	
87715-6522					15 MICROINCH	
87715-6523					GOLD FLASH	
87715-6524					10 MICROINCH	
87715-6525					15 MICROINCH	
87715-6526	30 MICROINCH	2.54				
87715-6527	GOLD FLASH	2.30				
87715-6528	15 MICROINCH					
87715-6530	64	NYLON66	GREEN (348C)	BRASS	GOLD FLASH	2.54
87715-6531					10 MICROINCH	
87715-6532					15 MICROINCH	
87715-6533					GOLD FLASH	
87715-6534					10 MICROINCH	
87715-6535					15 MICROINCH	
87715-6536	30 MICROINCH	2.54				
87715-6537	GOLD FLASH	2.30				
87715-6538	15 MICROINCH					
87715-6540	64	NYLON66	PURPLE (2736U)	BRASS	GOLD FLASH	2.54
87715-6541					10 MICROINCH	
87715-6542					15 MICROINCH	
87715-6543					GOLD FLASH	
87715-6544					10 MICROINCH	
87715-6545					15 MICROINCH	
87715-6546	30 MICROINCH	2.54				
87715-6547	GOLD FLASH	2.30				
87715-6548	15 MICROINCH					

SEE SHEET 2008/10/17

EC NO: SH2009-0199 2008/10/13
 DRWNG:GWANG08 2008/10/17
 CHK:DMZHANG02 2008/10/17
 APPR:HWANG 2008/11/03

DESCRIPTION
 REV

QUALITY SYMBOLS	GENERAL TOLERANCES (UNLESS SPECIFIED)	
	mm	INCH
▽=0	4 PLACES ± --- ± ---	
▽=0	3 PLACES ± --- ± ---	
	2 PLACES ± 0.25 ± ---	
	1 PLACE ± 0.25 ± ---	
	ANGULAR ± 3 °	
	DRAFT WHERE APPLICABLE MUST REMAIN WITHIN DIMENSIONS	

DIMENSION STYLE	
MM ONLY	
DRAWN BY	DATE
TOM	2004/07/20
CHECKED BY	DATE
ALLEN LIN	2004/07/20
APPROVED BY	DATE
WILSON	2004/07/20
MATERIAL NO.	DOCUMENT NO.
SEE TABLE	SD-87715-207
SIZE A3	THIS DRAWING CONTAINS INFORMATION THAT IS PROPRIETARY TO MOLEX INCORPORATED AND SHOULD NOT BE USED WITHOUT WRITTEN PERMISSION

SCALE	DESIGN UNITS	THIRD ANGLE PROJECTION
	METRIC 2008/10/17	
PCI EXPRESS EDGE CARD CONNECTOR (LEAD FREE VERSION)		
MOLEX INCORPORATED		
MATERIAL NO.		SHEET NO.
SEE TABLE		6 OF 11

MOLEX P/N	CIRCUIT SIZE	HOUSING MATERIAL	HOUSING COLOR	TERMINAL MATERIAL	CONTACT PLATING	SOLDER TAIL 'D' LENGTH	
87715-6600	98	NYLON66	BLACK	BRASS	GOLD FLASH	2.54	
87715-6601					10 MICROINCH		
87715-6602					15 MICROINCH		
87715-6603					GOLD FLASH		3.00
87715-6604					10 MICROINCH		
87715-6605					15 MICROINCH		
87715-6606					30 MICROINCH		2.54
87715-6607					GOLD FLASH		2.30
87715-6608					15 MICROINCH		
87715-6610					GOLD FLASH		98
87715-6611	10 MICROINCH						
87715-6612	15 MICROINCH						
87715-6613	GOLD FLASH	3.00					
87715-6614	10 MICROINCH						
87715-6615	15 MICROINCH						
87715-6616	30 MICROINCH	2.54					
87715-6617	GOLD FLASH	2.30					
87715-6618	15 MICROINCH						
87715-6620	GOLD FLASH	98	NYLON66	BLUE (287U)	BRASS	GOLD FLASH	
87715-6621	10 MICROINCH						
87715-6622	15 MICROINCH						
87715-6623	GOLD FLASH					3.00	
87715-6624	10 MICROINCH						
87715-6625	15 MICROINCH						
87715-6626	30 MICROINCH					2.54	
87715-6627	GOLD FLASH					2.30	
87715-6628	15 MICROINCH						
87715-6630	GOLD FLASH					98	NYLON66
87715-6631	10 MICROINCH						
87715-6632	15 MICROINCH						
87715-6633	GOLD FLASH	3.00					
87715-6634	10 MICROINCH						
87715-6635	15 MICROINCH						
87715-6636	30 MICROINCH	2.54					
87715-6637	GOLD FLASH	2.30					
87715-6638	15 MICROINCH						
87715-6640	GOLD FLASH	98	NYLON66	PURPLE (2736U)	BRASS		
87715-6641	10 MICROINCH						
87715-6642	15 MICROINCH						
87715-6643	GOLD FLASH					3.00	
87715-6644	10 MICROINCH						
87715-6645	15 MICROINCH						
87715-6646	30 MICROINCH					2.54	
87715-6647	GOLD FLASH					2.30	
87715-6648	15 MICROINCH						

MOLEX P/N	CIRCUIT SIZE	HOUSING MATERIAL	HOUSING COLOR	TERMINAL MATERIAL	CONTACT PLATING	SOLDER TAIL 'D' LENGTH	
87715-6700	164	NYLON66	BLACK	BRASS	GOLD FLASH	2.54	
87715-6701					10 MICROINCH		
87715-6702					15 MICROINCH		
87715-6703					GOLD FLASH		3.00
87715-6704					10 MICROINCH		
87715-6705					15 MICROINCH		
87715-6706					30 MICROINCH		2.54
87715-6707					GOLD FLASH		2.30
87715-6708					15 MICROINCH		
87715-6710					GOLD FLASH		164
87715-6711	10 MICROINCH						
87715-6712	15 MICROINCH						
87715-6713	GOLD FLASH	3.00					
87715-6714	10 MICROINCH						
87715-6715	15 MICROINCH						
87715-6716	30 MICROINCH	2.54					
87715-6717	GOLD FLASH	2.30					
87715-6718	15 MICROINCH						
87715-6720	GOLD FLASH	164	NYLON66	BLUE (287U)	BRASS	GOLD FLASH	
87715-6721	10 MICROINCH						
87715-6722	15 MICROINCH						
87715-6723	GOLD FLASH					3.00	
87715-6724	10 MICROINCH						
87715-6725	15 MICROINCH						
87715-6726	30 MICROINCH					2.54	
87715-6727	GOLD FLASH					2.30	
87715-6728	15 MICROINCH						
87715-6730	GOLD FLASH					164	NYLON66
87715-6731	10 MICROINCH						
87715-6732	15 MICROINCH						
87715-6733	GOLD FLASH	3.00					
87715-6734	10 MICROINCH						
87715-6735	15 MICROINCH						
87715-6736	30 MICROINCH	2.54					
87715-6737	GOLD FLASH	2.30					
87715-6738	15 MICROINCH						
87715-6740	GOLD FLASH	164	NYLON66	PURPLE (2736U)	BRASS		
87715-6741	10 MICROINCH						
87715-6742	15 MICROINCH						
87715-6743	GOLD FLASH					3.00	
87715-6744	10 MICROINCH						
87715-6745	15 MICROINCH						
87715-6746	30 MICROINCH					2.54	
87715-6747	GOLD FLASH					2.30	
87715-6748	15 MICROINCH						

SEE SHEET 2408/10/17
 EC NO: SH2009-0199
 DRWN:GWANG08 2008/10/13
 CH'KD:DMZHANG02 2008/10/17
 APPR:HWANG 2008/11/03

QUALITY SYMBOLS	GENERAL TOLERANCES (UNLESS SPECIFIED)	
	mm	INCH
▽=0	4 PLACES ± ---	± ---
▽=0	3 PLACES ± ---	± ---
	2 PLACES ± 0.25	± ---
	1 PLACE ± 0.25	± ---
	ANGULAR ± 3 °	

DIMENSION STYLE		SCALE	DESIGN UNITS
MM ONLY			METRIC
DRAWN BY	DATE	TITLE	
TOM	2004/07/20	PCI EXPRESS	
CHECKED BY	DATE	EDGE CARD CONNECTOR	
ALLEN LIN	2004/07/20	(LEAD FREE VERSION)	
APPROVED BY	DATE	MOLEX INCORPORATED	
WILSON	2004/07/20	MOLEX INCORPORATED	
MATERIAL NO.	DOCUMENT NO.	SHEET NO.	
SEE TABLE	SD-87715-207	7 OF 11	

THIRD ANGLE PROJECTION

THIS DRAWING CONTAINS INFORMATION THAT IS PROPRIETARY TO MOLEX INCORPORATED AND SHOULD NOT BE USED WITHOUT WRITTEN PERMISSION

MOLEX P/N	CIRCUIT SIZE	HOUSING MATERIAL	HOUSING COLOR	TERMINAL MATERIAL	CONTACT PLATING	SOLDER TAIL 'D' LENGTH	
87715-9000	36	NYLON46	BLACK	PHOSPHOR BRONZE	GOLD FLASH	2.54	
87715-9001					10 MICROINCH		
87715-9002					15 MICROINCH		
87715-9003					GOLD FLASH		
87715-9004					10 MICROINCH		3.00
87715-9005					15 MICROINCH		
87715-9006					30 MICROINCH		2.54
87715-9007					GOLD FLASH		2.30
87715-9008					15 MICROINCH		
87715-9009	30 MICROINCH	3.00					
87715-9010	36	NYLON46	WHITE	PHOSPHOR BRONZE	GOLD FLASH	2.54	
87715-9011					10 MICROINCH		
87715-9012					15 MICROINCH		
87715-9013					GOLD FLASH		
87715-6014					10 MICROINCH		3.00
87715-9015					15 MICROINCH		
87715-9016					30 MICROINCH		2.54
87715-9017					GOLD FLASH		2.30
87715-9018					15 MICROINCH		
87715-9020	36	NYLON46	BLUE (287U)	PHOSPHOR BRONZE	GOLD FLASH	2.54	
87715-9021					10 MICROINCH		
87715-9022					15 MICROINCH		
87715-9023					GOLD FLASH		
87715-9024					10 MICROINCH		3.00
87715-9025					15 MICROINCH		
87715-9026					30 MICROINCH		2.54
87715-9027					GOLD FLASH		2.30
87715-9028					15 MICROINCH		
87715-9030	36	NYLON46	GREEN (348C)	PHOSPHOR BRONZE	GOLD FLASH	2.54	
87715-9031					10 MICROINCH		
87715-9032					15 MICROINCH		
87715-9033					GOLD FLASH		
87715-9034					10 MICROINCH		3.00
87715-9035					15 MICROINCH		
87715-9036					30 MICROINCH		2.54
87715-9037					GOLD FLASH		2.30
87715-9038					15 MICROINCH		
87715-9040	36	NYLON46	PURPLE (2736U)	PHOSPHOR BRONZE	GOLD FLASH	2.54	
87715-9041					10 MICROINCH		
87715-9042					15 MICROINCH		
87715-9043					GOLD FLASH		
87715-9044					10 MICROINCH		3.00
87715-9045					15 MICROINCH		
87715-9046					30 MICROINCH		2.54
87715-9047					GOLD FLASH		2.30
87715-9048					15 MICROINCH		

MOLEX P/N	CIRCUIT SIZE	HOUSING MATERIAL	HOUSING COLOR	TERMINAL MATERIAL	CONTACT PLATING	SOLDER TAIL 'D' LENGTH	
87715-9100	64	NYLON46	BLACK	PHOSPHOR BRONZE	GOLD FLASH	2.54	
87715-9101					10 MICROINCH		
87715-9102					15 MICROINCH		
87715-9103					GOLD FLASH		
87715-9104					10 MICROINCH		3.00
87715-9105					15 MICROINCH		
87715-9106					30 MICROINCH		2.54
87715-9107					GOLD FLASH		2.30
87715-9108					15 MICROINCH		
87715-9109	30 MICROINCH	3.00					
87715-9110	64	NYLON46	WHITE	PHOSPHOR BRONZE	GOLD FLASH	2.54	
87715-9111					10 MICROINCH		
87715-9112					15 MICROINCH		
87715-9113					GOLD FLASH		
87715-9114					10 MICROINCH		3.00
87715-9115					15 MICROINCH		
87715-9116					30 MICROINCH		2.54
87715-9117					GOLD FLASH		2.30
87715-9118					15 MICROINCH		
87715-9120	64	NYLON46	BLUE (287U)	PHOSPHOR BRONZE	GOLD FLASH	2.54	
87715-9121					10 MICROINCH		
87715-9122					15 MICROINCH		
87715-9123					GOLD FLASH		
87715-9124					10 MICROINCH		3.00
87715-9125					15 MICROINCH		
87715-9126					30 MICROINCH		2.54
87715-9127					GOLD FLASH		2.30
87715-9128					15 MICROINCH		
87715-9130	64	NYLON46	GREEN (348C)	PHOSPHOR BRONZE	GOLD FLASH	2.54	
87715-9131					10 MICROINCH		
87715-9132					15 MICROINCH		
87715-9133					GOLD FLASH		
87715-9134					10 MICROINCH		3.00
87715-9135					15 MICROINCH		
87715-9136					30 MICROINCH		2.54
87715-9137					GOLD FLASH		2.30
87715-9138					15 MICROINCH		
87715-9140	64	NYLON46	PURPLE (2736U)	PHOSPHOR BRONZE	GOLD FLASH	2.54	
87715-9141					10 MICROINCH		
87715-9142					15 MICROINCH		
87715-9143					GOLD FLASH		
87715-9144					10 MICROINCH		3.00
87715-9145					15 MICROINCH		
87715-9146					30 MICROINCH		2.54
87715-9147					GOLD FLASH		2.30
87715-9148					15 MICROINCH		

SEE SHEET 2008/10/17

EC NO: SH2009-0199 2008/10/13
 DRW:GMANG08 2008/10/17
 CHK:DMZHANG02 2008/10/17
 APPR:HMWANG 2008/11/03

REV

QUALITY SYMBOLS

▽=0
 ◁=0

GENERAL TOLERANCES (UNLESS SPECIFIED)

	mm	INCH
4 PLACES	± .005	± .0004
3 PLACES	± .008	± .0003
2 PLACES	± 0.25	± .010
1 PLACE	± 0.25	± .010

ANGULAR ± 3 °

DRAFT WHERE APPLICABLE MUST REMAIN WITHIN DIMENSIONS

DIMENSION STYLE

MM ONLY

DRAWN BY: TOM DATE: 2004/07/20

CHECKED BY: ALLEN LIN DATE: 2004/07/20

APPROVED BY: WILSON DATE: 2004/07/20

MATERIAL NO. SEE TABLE

SCALE

DESIGN UNITS

METRIC

THIRD ANGLE PROJECTION

PCI EXPRESS
 EDGE CARD CONNECTOR
 (LEAD FREE VERSION)

MOLEX MOLEX INCORPORATED

DOCUMENT NO. SD-87715-207

SHEET NO. 8 OF 11

THIS DRAWING CONTAINS INFORMATION THAT IS PROPRIETARY TO MOLEX INCORPORATED AND SHOULD NOT BE USED WITHOUT WRITTEN PERMISSION

10 9 8 7 6 5 4 3 2 1

MOLEX P/N	CIRCUIT SIZE	HOUSING MATERIAL	HOUSING COLOR	TERMINAL MATERIAL	CONTACT PLATING	SOLDER TAIL 'D' LENGTH
87715-9200	98	NYLON46	BLACK	PHOSPHOR BRONZE	GOLD FLASH	2.54
87715-9201					10 MICROINCH	
87715-9202					15 MICROINCH	
87715-9203					GOLD FLASH	
87715-9204					10 MICROINCH	
87715-9205					15 MICROINCH	
87715-9206					30 MICROINCH	
87715-9207					GOLD FLASH	
87715-9208					15 MICROINCH	
87715-9209	30 MICROINCH	3.00				
87715-9210	98	NYLON46	WHITE	PHOSPHOR BRONZE	GOLD FLASH	2.54
87715-9211					10 MICROINCH	
87715-9212					15 MICROINCH	
87715-9213					GOLD FLASH	
87715-9214					10 MICROINCH	
87715-9215					15 MICROINCH	
87715-9216					30 MICROINCH	
87715-9217					GOLD FLASH	
87715-9218					15 MICROINCH	
87715-9220	98	NYLON46	BLUE (287U)	PHOSPHOR BRONZE	GOLD FLASH	2.54
87715-9221					10 MICROINCH	
87715-9222					15 MICROINCH	
87715-9223					GOLD FLASH	
87715-9224					10 MICROINCH	
87715-9225					15 MICROINCH	
87715-9226					30 MICROINCH	
87715-9227					GOLD FLASH	
87715-9228					15 MICROINCH	
87715-9230	98	NYLON46	GREEN (348C)	PHOSPHOR BRONZE	GOLD FLASH	2.54
87715-9231					10 MICROINCH	
87715-9232					15 MICROINCH	
87715-9233					GOLD FLASH	
87715-9234					10 MICROINCH	
87715-9235					15 MICROINCH	
87715-9236					30 MICROINCH	
87715-9237					GOLD FLASH	
87715-9238					15 MICROINCH	
87715-9240	98	NYLON46	PURPLE (2736U)	PHOSPHOR BRONZE	GOLD FLASH	2.54
87715-9241					10 MICROINCH	
87715-9242					15 MICROINCH	
87715-9243					GOLD FLASH	
87715-9244					10 MICROINCH	
87715-9245					15 MICROINCH	
87715-9246					30 MICROINCH	
87715-9247					GOLD FLASH	
87715-9248					15 MICROINCH	

MOLEX P/N	CIRCUIT SIZE	HOUSING MATERIAL	HOUSING COLOR	TERMINAL MATERIAL	CONTACT PLATING	SOLDER TAIL 'D' LENGTH
87715-9300	164	NYLON46	BLACK	PHOSPHOR BRONZE	GOLD FLASH	2.54
87715-9301					10 MICROINCH	
87715-9302					15 MICROINCH	
87715-9303					GOLD FLASH	
87715-9304					10 MICROINCH	
87715-9305					15 MICROINCH	
87715-9306					30 MICROINCH	
87715-9307					GOLD FLASH	
87715-9308					15 MICROINCH	
87715-9309	30 MICROINCH	3.00				
87715-9310	164	NYLON46	WHITE	PHOSPHOR BRONZE	GOLD FLASH	2.54
87715-9311					10 MICROINCH	
87715-9312					15 MICROINCH	
87715-9313					GOLD FLASH	
87715-9314					10 MICROINCH	
87715-9315					15 MICROINCH	
87715-9316					30 MICROINCH	
87715-9317					GOLD FLASH	
87715-9318					15 MICROINCH	
87715-9320	164	NYLON46	BLUE (287U)	PHOSPHOR BRONZE	GOLD FLASH	2.54
87715-9321					10 MICROINCH	
87715-9322					15 MICROINCH	
87715-9323					GOLD FLASH	
87715-9324					10 MICROINCH	
87715-9325					15 MICROINCH	
87715-9326					30 MICROINCH	
87715-9327					GOLD FLASH	
87715-9328					15 MICROINCH	
87715-9330	164	NYLON46	GREEN (348C)	PHOSPHOR BRONZE	GOLD FLASH	2.54
87715-9331					10 MICROINCH	
87715-9332					15 MICROINCH	
87715-9333					GOLD FLASH	
87715-9334					10 MICROINCH	
87715-9335					15 MICROINCH	
87715-9336					30 MICROINCH	
87715-9337					GOLD FLASH	
87715-9338					15 MICROINCH	
87715-9340	164	NYLON46	PURPLE (2736U)	PHOSPHOR BRONZE	GOLD FLASH	2.54
87715-9341					10 MICROINCH	
87715-9342					15 MICROINCH	
87715-9343					GOLD FLASH	
87715-9344					10 MICROINCH	
87715-9345					15 MICROINCH	
87715-9346					30 MICROINCH	
87715-9347					GOLD FLASH	
87715-9348					15 MICROINCH	
87715-9352	164	NYLON46	BLUE (659C)	PHOSPHOR BRONZE	GOLD FLASH	2.54
87715-9355					15 MICROINCH	3.00

▽

SEE SHEET 1
 EC NO: SH2009-0199 2008/10/17
 DRW:GWANG08 2008/10/15
 CHK:DMZHANG02 2008/10/17
 APPR:HWANG 2008/11/03

QUALITY SYMBOLS
 ▽=0
 ▽=0

GENERAL TOLERANCES (UNLESS SPECIFIED)

	mm	INCH
4 PLACES	± .005	± .0004
3 PLACES	± .005	± .0004
2 PLACES	± 0.25	± .010
1 PLACE	± 0.25	± .010
ANGULAR ± 3 °		

DRAFT WHERE APPLICABLE MUST REMAIN WITHIN DIMENSIONS

DIMENSION STYLE
MM ONLY

DRAWN BY: TOM DATE: 2004/07/20
 CHECKED BY: ALLEN LIN DATE: 2004/07/20
 APPROVED BY: WILSON DATE: 2004/07/20

MATERIAL NO. SEE TABLE

SCALE
 DESIGN UNITS
METRIC

THIRD ANGLE PROJECTION

PCI EXPRESS
 EDGE CARD CONNECTOR
 (LEAD FREE VERSION)

MOLEX INCORPORATED

DOCUMENT NO. SD-87715-207 SHEET NO. 9 OF 11

THIS DRAWING CONTAINS INFORMATION THAT IS PROPRIETARY TO MOLEX INCORPORATED AND SHOULD NOT BE USED WITHOUT WRITTEN PERMISSION

9 8 7 6 5 4 3 2 1

MOLEX P/N	CIRCUIT SIZE	HOUSING MATERIAL	HOUSING COLOR	TERMINAL MATERIAL	CONTACT PLATING	SOLDER TAIL 'D' LENGTH	
87715-9400	36	NYLON46	BLACK	BRASS	GOLD FLASH	2.54	
87715-9401					10 MICROINCH		
87715-9402					15 MICROINCH		
87715-9403					GOLD FLASH		3.00
87715-9404					10 MICROINCH		
87715-9405					15 MICROINCH		
87715-9406					30 MICROINCH		2.54
87715-9407					GOLD FLASH		2.30
87715-9408					15 MICROINCH		
87715-9410					GOLD FLASH		36
87715-9411	10 MICROINCH						
87715-9412	15 MICROINCH						
87715-9413	GOLD FLASH	3.00					
87715-9414	10 MICROINCH						
87715-9415	15 MICROINCH						
87715-9416	30 MICROINCH	2.54					
87715-9417	GOLD FLASH	2.30					
87715-9418	15 MICROINCH						
87715-9420	36	NYLON46	BLUE (287U)	BRASS	GOLD FLASH	2.54	
87715-9421					10 MICROINCH		
87715-9422					15 MICROINCH		
87715-9423					GOLD FLASH		3.00
87715-9424					10 MICROINCH		
87715-9425					15 MICROINCH		
87715-9426					30 MICROINCH		2.54
87715-9427					GOLD FLASH		2.30
87715-9428					15 MICROINCH		
87715-9430					36		NYLON46
87715-9431	10 MICROINCH						
87715-9432	15 MICROINCH						
87715-9433	GOLD FLASH	3.00					
87715-9434	10 MICROINCH						
87715-9435	15 MICROINCH						
87715-9436	30 MICROINCH	2.54					
87715-9437	GOLD FLASH	2.30					
87715-9438	15 MICROINCH						
87715-9440	36	NYLON46	PURPLE (2736U)	BRASS		GOLD FLASH	
87715-9441					10 MICROINCH		
87715-9442					15 MICROINCH		
87715-9443					GOLD FLASH	3.00	
87715-9444					10 MICROINCH		
87715-9445					15 MICROINCH		
87715-9446					30 MICROINCH	2.54	
87715-9447					GOLD FLASH	2.30	
87715-9448					15 MICROINCH		

MOLEX P/N	CIRCUIT SIZE	HOUSING MATERIAL	HOUSING COLOR	TERMINAL MATERIAL	CONTACT PLATING	SOLDER TAIL 'D' LENGTH	
87715-9500	64	NYLON46	BLACK	BRASS	GOLD FLASH	2.54	
87715-9501					10 MICROINCH		
87715-9502					15 MICROINCH		
87715-9503					GOLD FLASH		3.00
87715-9504					10 MICROINCH		
87715-9505					15 MICROINCH		
87715-9506					30 MICROINCH		2.54
87715-9507					GOLD FLASH		2.30
87715-9508					15 MICROINCH		
87715-9510					64		NYLON46
87715-9511	10 MICROINCH						
87715-9512	15 MICROINCH						
87715-9513	GOLD FLASH	3.00					
87715-9514	10 MICROINCH						
87715-9515	15 MICROINCH						
87715-9516	30 MICROINCH	2.54					
87715-9517	GOLD FLASH	2.30					
87715-9518	15 MICROINCH						
87715-9520	64	NYLON46	BLUE (287U)	BRASS		GOLD FLASH	
87715-9521					10 MICROINCH		
87715-9522					15 MICROINCH		
87715-9523					GOLD FLASH	3.00	
87715-9524					10 MICROINCH		
87715-9525					15 MICROINCH		
87715-9526					30 MICROINCH	2.54	
87715-9527					GOLD FLASH	2.30	
87715-9528					15 MICROINCH		
87715-9530					64	NYLON46	GREEN (348C)
87715-9531	10 MICROINCH						
87715-9532	15 MICROINCH						
87715-9533	GOLD FLASH	3.00					
87715-9534	10 MICROINCH						
87715-9535	15 MICROINCH						
87715-9536	30 MICROINCH	2.54					
87715-9537	GOLD FLASH	2.30					
87715-9538	15 MICROINCH						
87715-9540	64	NYLON46	PURPLE (2736U)	BRASS			
87715-9541					10 MICROINCH		
87715-9542					15 MICROINCH		
87715-9543					GOLD FLASH	3.00	
87715-9544					10 MICROINCH		
87715-9545					15 MICROINCH		
87715-9546					30 MICROINCH	2.54	
87715-9547					GOLD FLASH	2.30	
87715-9548					15 MICROINCH		

SEE SHEET 1 2008/10/17
 EC NO: SH2009-0199
 TDRW:GWANG08 2008/10/13
 CHKD:DMZHANG02 2008/10/17
 APPR:HWANG 2008/11/03

QUALITY SYMBOLS	DESCRIPTION
	=0.05
	=0.1

GENERAL TOLERANCES (UNLESS SPECIFIED)	DIMENSION STYLE	
	mm	INCH
4 PLACES	± ---	± ---
3 PLACES	± ---	± ---
2 PLACES	± 0.25	± ---
1 PLACE	± 0.25	± ---
ANGULAR ± 3 °		
DRAFT WHERE APPLICABLE MUST REMAIN WITHIN DIMENSIONS		

DIMENSION STYLE		SCALE	DESIGN UNITS
MM ONLY			METRIC
DRAWN BY	DATE	TITLE	
TOM	2004/07/20	PCI EXPRESS	
CHECKED BY	DATE	EDGE CARD CONNECTOR	
ALLEN LIN	2004/07/20	(LEAD FREE VERSION)	
APPROVED BY	DATE	MOLEX INCORPORATED	
WILSON	2004/07/20	MOLEX INCORPORATED	
MATERIAL NO.	DOCUMENT NO.	SHEET NO.	
SEE TABLE	SD-87715-207	10 OF 11	

THIRD ANGLE PROJECTION	
PCI EXPRESS	
EDGE CARD CONNECTOR	
(LEAD FREE VERSION)	
MOLEX INCORPORATED	
DOCUMENT NO. SD-87715-207	
SHEET NO. 10 OF 11	
THIS DRAWING CONTAINS INFORMATION THAT IS PROPRIETARY TO MOLEX INCORPORATED AND SHOULD NOT BE USED WITHOUT WRITTEN PERMISSION	

MOLEX P/N	CIRCUIT SIZE	HOUSING MATERIAL	HOUSING COLOR	TERMINAL MATERIAL	CONTACT PLATING	SOLDER TAIL 'D' LENGTH	
87715-9600	98	NYLON46	BLACK	BRASS	GOLD FLASH	2.54	
87715-9601					10 MICROINCH		
87715-9602					15 MICROINCH		
87715-9603					GOLD FLASH		
87715-9604					10 MICROINCH		3.00
87715-9605					15 MICROINCH		
87715-9606					30 MICROINCH		2.54
87715-9607					GOLD FLASH		2.30
87715-9608	15 MICROINCH						
87715-9610	98	NYLON46	WHITE	BRASS	GOLD FLASH	2.54	
87715-9611					10 MICROINCH		
87715-9612					15 MICROINCH		
87715-9613					GOLD FLASH		
87715-9614					10 MICROINCH		3.00
87715-9615					15 MICROINCH		
87715-9616					30 MICROINCH		2.54
87715-9617					GOLD FLASH		2.30
87715-9618	15 MICROINCH						
87715-9620	98	NYLON46	BLUE (287U)	BRASS	GOLD FLASH	2.54	
87715-9621					10 MICROINCH		
87715-9622					15 MICROINCH		
87715-9623					GOLD FLASH		
87715-9624					10 MICROINCH		3.00
87715-9625					15 MICROINCH		
87715-9626					30 MICROINCH		2.54
87715-9627					GOLD FLASH		2.30
87715-9628	15 MICROINCH						
87715-9630	98	NYLON46	GREEN (348C)	BRASS	GOLD FLASH	2.54	
87715-9631					10 MICROINCH		
87715-9632					15 MICROINCH		
87715-9633					GOLD FLASH		
87715-9634					10 MICROINCH		3.00
87715-9635					15 MICROINCH		
87715-9636					30 MICROINCH		2.54
87715-9637					GOLD FLASH		2.30
87715-9638	15 MICROINCH						
87715-9640	98	NYLON46	PURPLE (2736U)	BRASS	GOLD FLASH	2.54	
87715-9641					10 MICROINCH		
87715-9642					15 MICROINCH		
87715-9643					GOLD FLASH		
87715-9644					10 MICROINCH		3.00
87715-9645					15 MICROINCH		
87715-9646					30 MICROINCH		2.54
87715-9647					GOLD FLASH		2.30
87715-9648	15 MICROINCH						

MOLEX P/N	CIRCUIT SIZE	HOUSING MATERIAL	HOUSING COLOR	TERMINAL MATERIAL	CONTACT PLATING	SOLDER TAIL 'D' LENGTH	
87715-9700	164	NYLON46	BLACK	BRASS	GOLD FLASH	2.54	
87715-9701					10 MICROINCH		
87715-9702					15 MICROINCH		
87715-9703					GOLD FLASH		
87715-9704					10 MICROINCH		3.00
87715-9705					15 MICROINCH		
87715-9706					30 MICROINCH		2.54
87715-9707					GOLD FLASH		2.30
87715-9708	15 MICROINCH						
87715-9710	164	NYLON46	WHITE	BRASS	GOLD FLASH	2.54	
87715-9711					10 MICROINCH		
87715-9712					15 MICROINCH		
87715-9713					GOLD FLASH		
87715-9714					10 MICROINCH		3.00
87715-9715					15 MICROINCH		
87715-9716					30 MICROINCH		2.54
87715-9717					GOLD FLASH		2.30
87715-9718	15 MICROINCH						
87715-9720	164	NYLON46	BLUE (287U)	BRASS	GOLD FLASH	2.54	
87715-9721					10 MICROINCH		
87715-9722					15 MICROINCH		
87715-9723					GOLD FLASH		
87715-9724					10 MICROINCH		3.00
87715-9725					15 MICROINCH		
87715-9726					30 MICROINCH		2.54
87715-9727					GOLD FLASH		2.30
87715-9728	15 MICROINCH						
87715-9730	164	NYLON46	GREEN (348C)	BRASS	GOLD FLASH	2.54	
87715-9731					10 MICROINCH		
87715-9732					15 MICROINCH		
87715-9733					GOLD FLASH		
87715-9734					10 MICROINCH		3.00
87715-9735					15 MICROINCH		
87715-9736					30 MICROINCH		2.54
87715-9737					GOLD FLASH		2.30
87715-9738	15 MICROINCH						
87715-9740	164	NYLON46	PURPLE (2736U)	BRASS	GOLD FLASH	2.54	
87715-9741					10 MICROINCH		
87715-9742					15 MICROINCH		
87715-9743					GOLD FLASH		
87715-9744					10 MICROINCH		3.00
87715-9745					15 MICROINCH		
87715-9746					30 MICROINCH		2.54
87715-9747					GOLD FLASH		2.30
87715-9748	15 MICROINCH						

SEE SHEET 1 2008/10/17
 EC NO: SHZ009-0199 2008/10/13
 T DRIVINGWANG08 2008/10/17
 CHK:DJZHANG02 2008/10/17
 APPR:HWANG 2008/11/03

QUALITY SYMBOLS	DESCRIPTION
	=0
	=0

GENERAL TOLERANCES (UNLESS SPECIFIED)	DIMENSION STYLE	
	mm	INCH
4 PLACES	± ---	± ---
3 PLACES	± ---	± ---
2 PLACES	± 0.25	± ---
1 PLACE	± 0.25	± ---
ANGULAR ± 3 °		
DRAFT WHERE APPLICABLE MUST REMAIN WITHIN DIMENSIONS		

DIMENSION STYLE		SCALE	DESIGN UNITS
MM ONLY			METRIC
DRAWN BY	DATE	TITLE	
TOM	2004/07/20	PCI EXPRESS EDGE CARD CONNECTOR (LEAD FREE VERSION)	
CHECKED BY	DATE		
ALLEN LIN	2004/07/20		
APPROVED BY	DATE	MOLEX INCORPORATED	
WILSON	2004/07/20		
MATERIAL NO.	DOCUMENT NO.	SHEET NO.	
SEE TABLE	SD-87715-207	11 OF 11	

THIRD ANGLE PROJECTION	
------------------------	--